

Nanosensors:

Transitioning Nanosensors from the laboratory
to the marketplace:
Challenges and Lessons learned

Wunmi Sadik

Department of Chemistry
State University of New
York-Binghamton



NNI Nanosensor Workshop
September 11-12th, 2014,
Washington, DC



Center for Advanced Sensors
& Environmental Systems

Science –to –Technology (S₂T)

- A vast amount of nanosensors have been developed, tried and tested
 - biosensors
 - electrochemical capacitors
 - batteries, fuel cells, novel membrane systems and many more
- There are many roadblocks in bridging the gap between academic research and the market place

Highlights

- Operational definitions
 - Category 1 nanosensor
 - Category 2 nanosensor
- Case studies-
 - *Ultra-sensitive Portable Capillary Sensor (U-PAC™)*
 - CeO₂, Fe₂O₃, TiO₂, ZnO, and fullerenes
- Testbeds and performance metrics
- Bridging the gap
 - a proposal for moving forward

How do you bridge the gap between research and commercialization?

Answer the two key questions of successful innovation:

- Can you make a product?
- Can you get anyone to buy it?

Nanosensor Classification

- **Type 1 Nanosensors:**
Nanotechnology-enabled sensors or sensors that are themselves nanoscale or have nanoscale materials or components
- **Type 2 Nanosensors:**
Nanoproperty-quantifiable sensors that are used to measure nanoscale properties

Sadik et al, Journal of Environmental Monitoring, 11, 25, 2009

Category 1 Nanosensors

- Hundreds of research articles using nanomaterials for chemical & biosensors have been published. There are dozens of reviews available which partly deal with use of nanomaterials for electrochemical nanobiosensors

- **Nanoparticles**
- **Nanowires**
- **Nanoneedles**
- **Nanosheets**
- **Nanotubes**
- **Nanorods**

Biosensors & Bioelectronics, **24**, 2749-2765, 2009.

Metal-Enhanced Electrochemical Detection (MED)

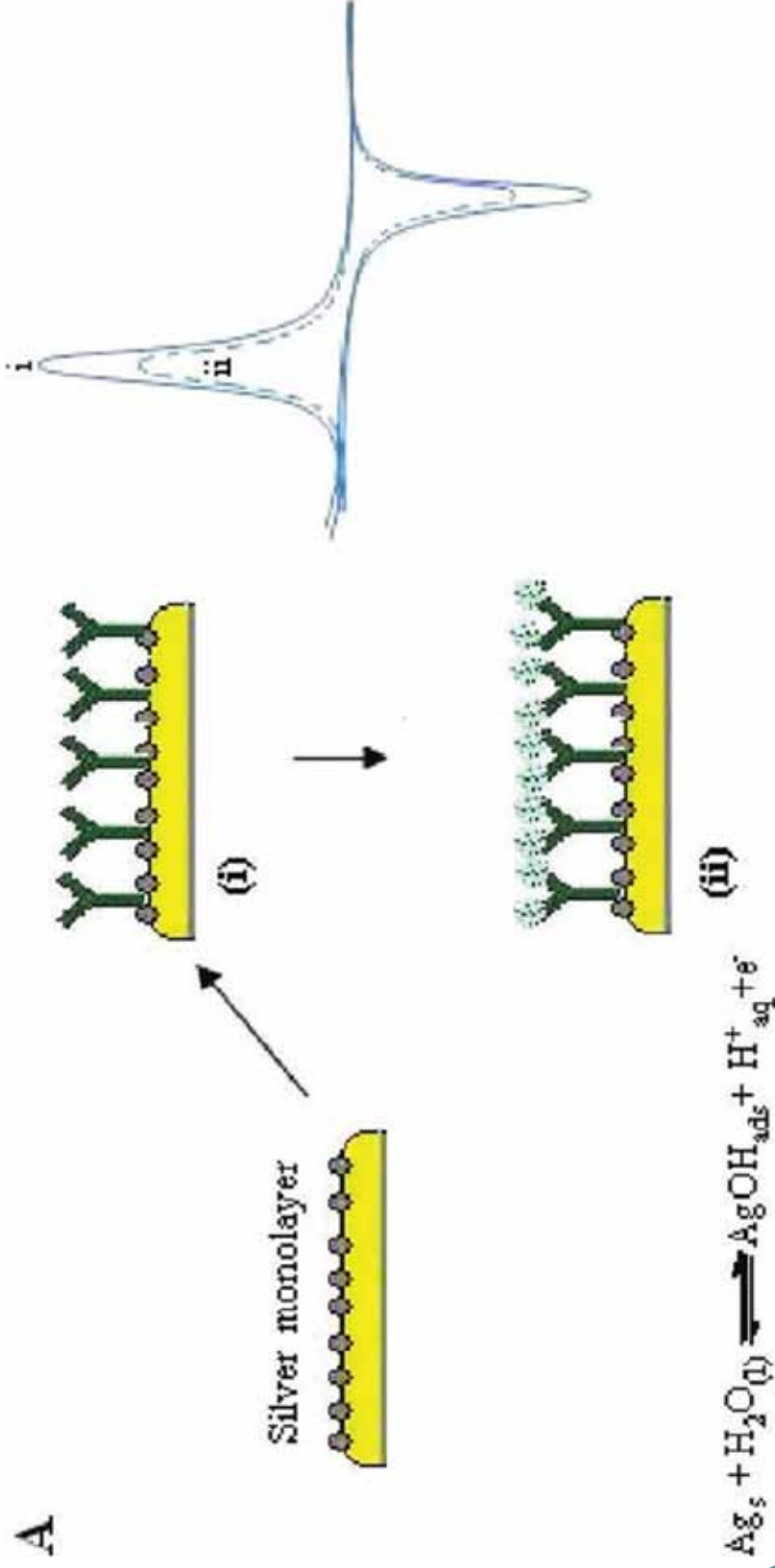

UPAC Biosensor

SUNY-Binghamton scientists and engineers have developed a portable, fully autonomous, and remotely operated sensing device, called Ultra-Sensitive Portable Capillary Sensor (U-PAC™)

1. Sadik, O., Karasinski, J, "Ultra-Sensitive, Portable Capillary Sensor", U.S. Patent No. 8,414,844 B2, April 9, 2013.
2. Sadik, O., Karasinski, J, "Ultra-Sensitive, Portable Capillary Sensor", U.S. Patent No. 7,708,944, May 5, 2010.
3. Sadik, O., Wang Q., Blythe, P., US Provisional Application No. 32291/1310 (RB-347), "Capillary Biosense and its Method of Use", April 19, 2010
5. *Analytical Chemistry*, 74,713-719, **2002**
6. Guide 101-10, March **2007**, US Department of Homeland Security, Preparedness Directorate, Office of Grants and Training Systems Support Division, Washington DC.

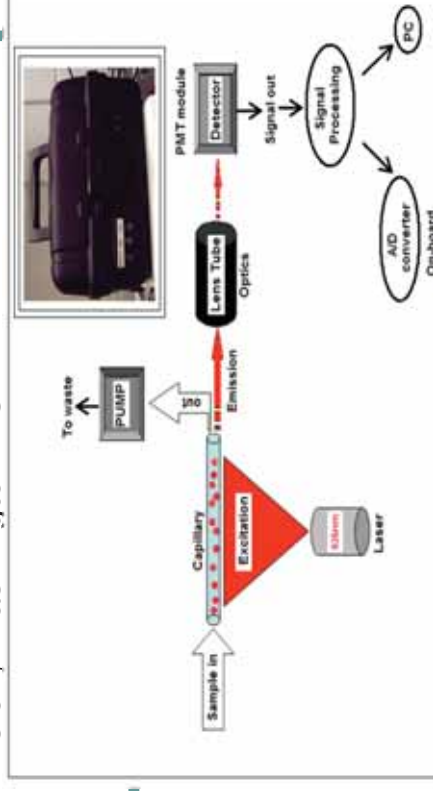

Performance Characteristics

Technique	LOD	Response Time	Sample Preparation
UPAC Biosensor	112 spores/ml	30 min	Minimal
Standard ELISA	4269 spores/ml	6hrs	Extensive
Standard PCR	250 spores/ml	12 hrs	Extensive (PCR extraction)
Optical Leaky Clad waveguide biosensor	10,000 spores/ml	40 min	Autonomous
DOX	Qualitative	30 min	Minimal

Conventional and emerging tools for characterizing engineered nanoparticles

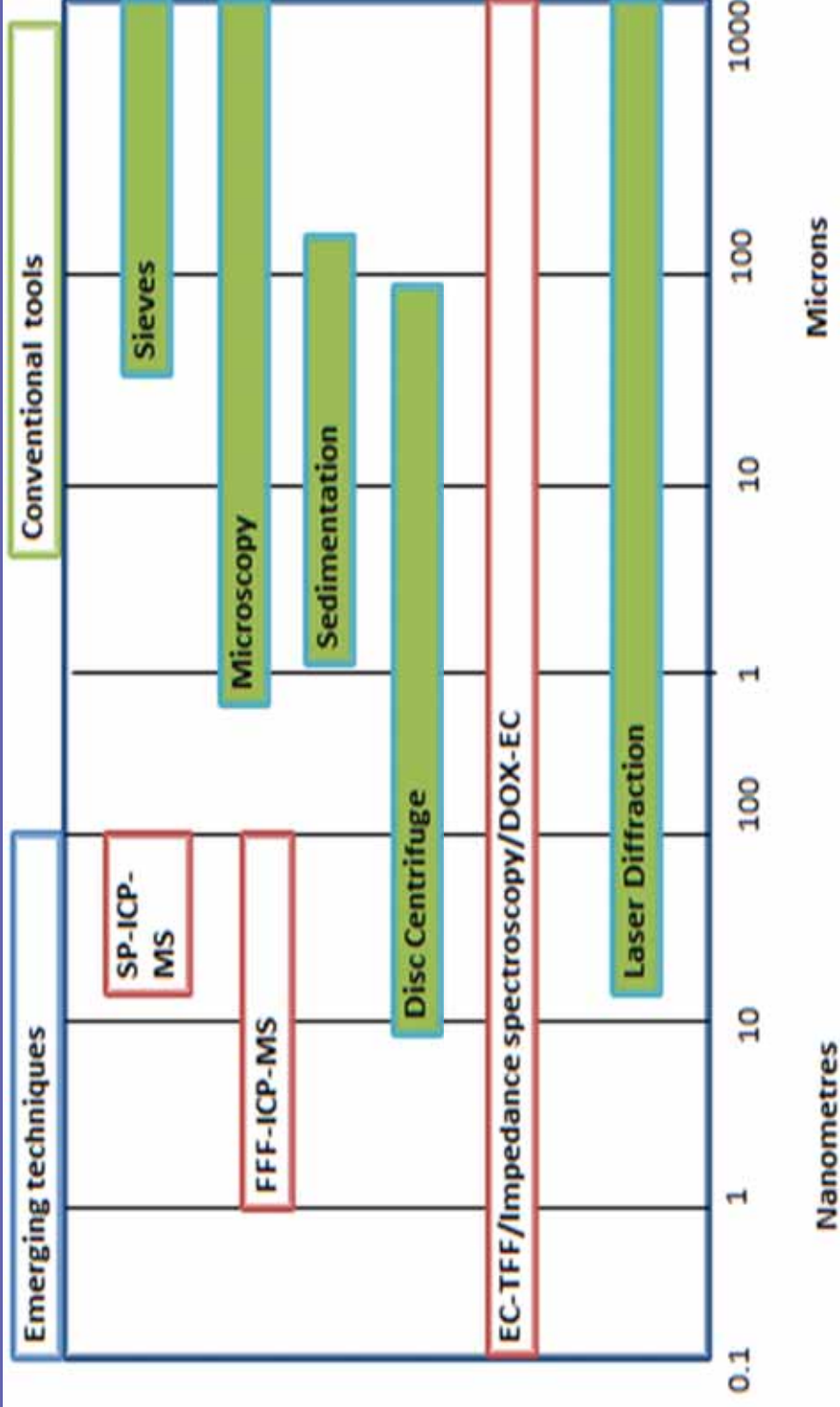

SP-ICP-MS= Single Particle Inductively Coupled Mass Spectrometer,
 FFF-ICP-MS=Fluid Flow Fractionation Inductively Coupled Mass Spectrometer,
 EC-TFF=Electro-Chemical Tangential Fluid Flow, DOX-EC=Dissolved oxygen Sensor
 coupled with Electrochemical technique, DLS= Dynamic Light Scattering.

Category 2:

Size-exclusive Nanosensors for Quantitative Analysis of Fullerenes

SADIK et al, ES&T 2011, 45, 5294 – 5294

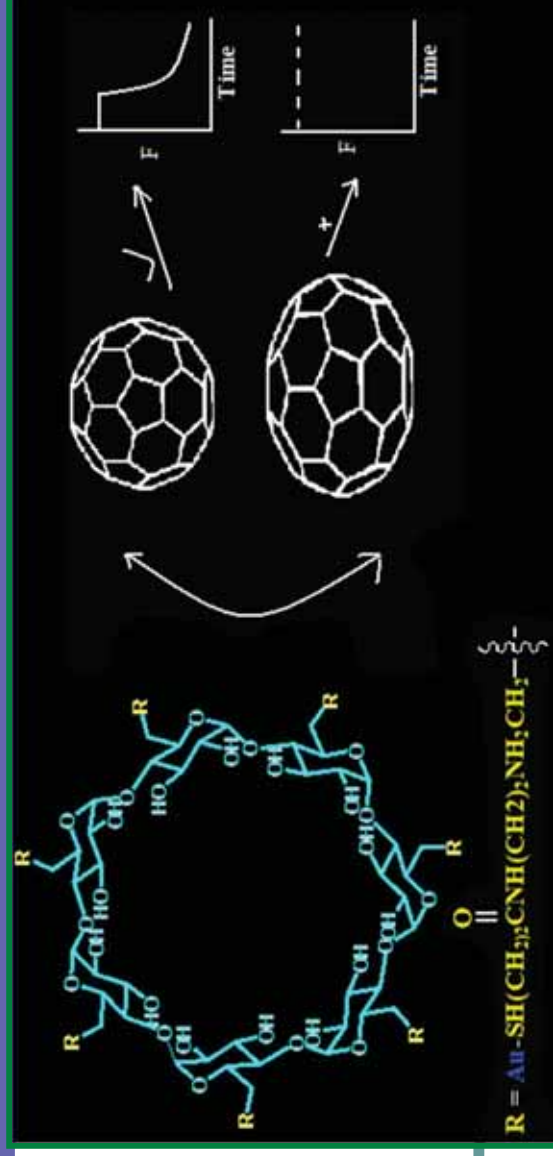

A single-use quantity of cosmetic (0.5 g) may contain up to 0.6 μg of C_{60} and demonstrates a pathway for human exposure to engineered fullerenes

Nanosensor Responses

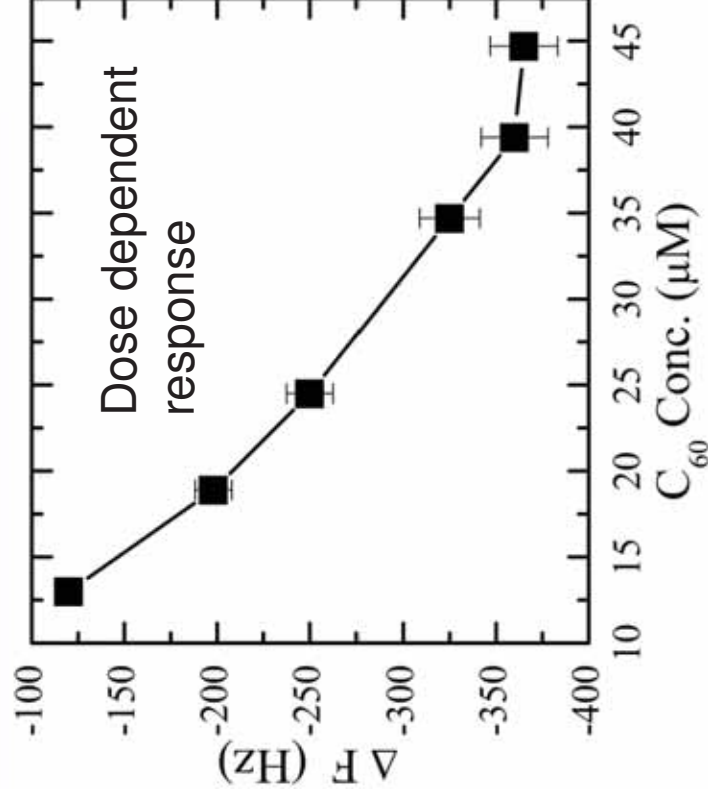
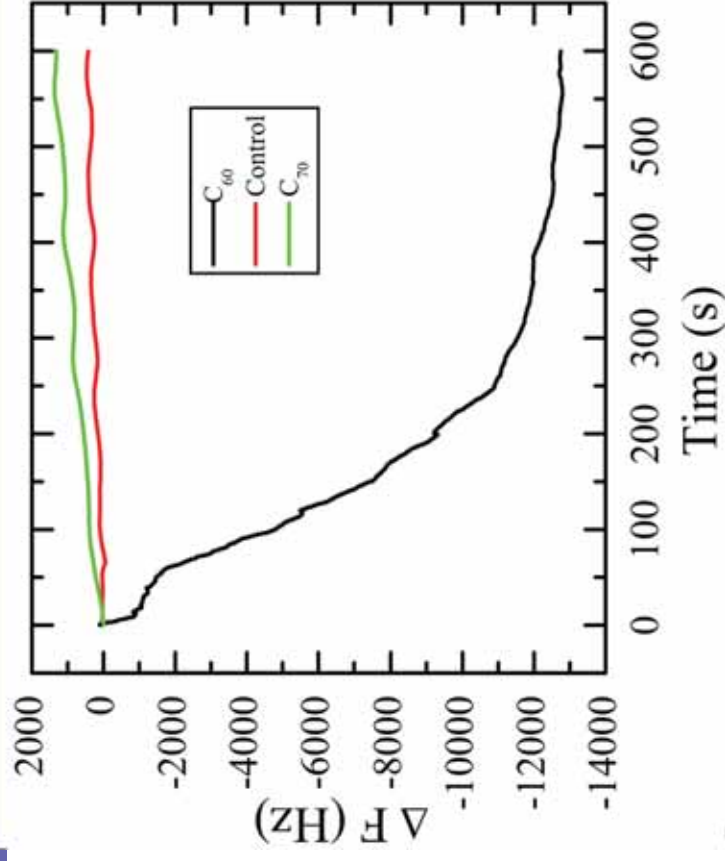

- Active sensing electrode surface area of 0.196 cm^2 , an equivalent of

2.02×10^{12} beta-CDs should fit on the QCM sensor

- At low concentrations, the ratio of $\beta\text{-CD}/C_{60}$ molecules was ~ 1.12 **C_{60}/cavity** which, is consistent with the host-guest chemistry of $\beta\text{-CD}-C_{60}$ 1:1 inclusion chemistry

Category 2:

Capture and Detection of Aerosol Nanoparticles using Poly (amic acid, Phase-inverted Membranes

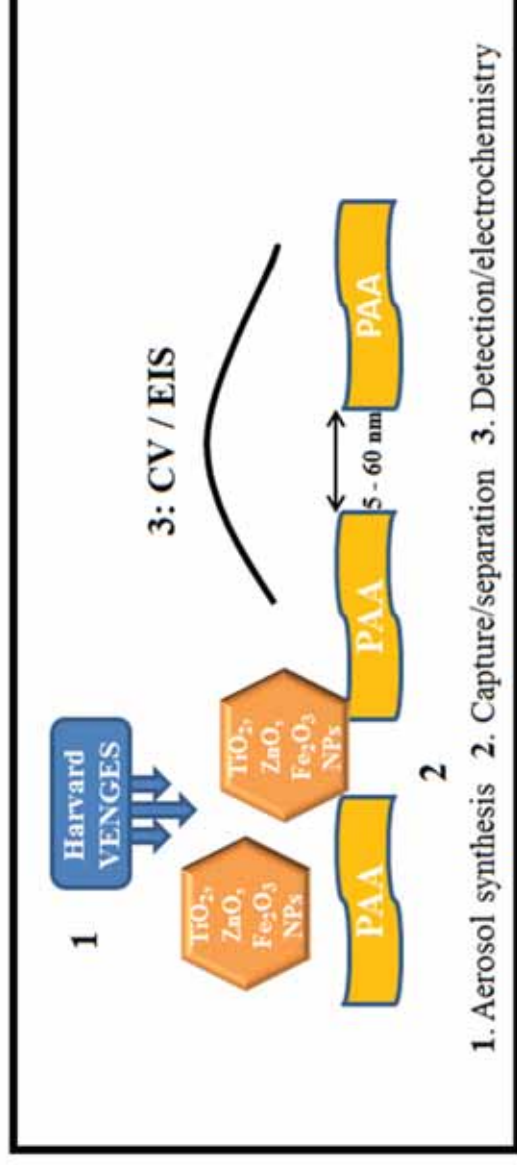

1. Aerosol synthesis 2. Capture/separation 3. Detection/electrochemistry



¹SUNY-BINGHAMTON, NY

² HARVARD SCHOOL OF PUBLIC HEALTH, MA, Sadik, Demokritou et al,

J. Hazardous Materials, 2014(In press), Nanoletters 2014

Harvard's VENGES

New Platform for pulmonary and cardiovascular toxicological characterization of inhaled ENMs

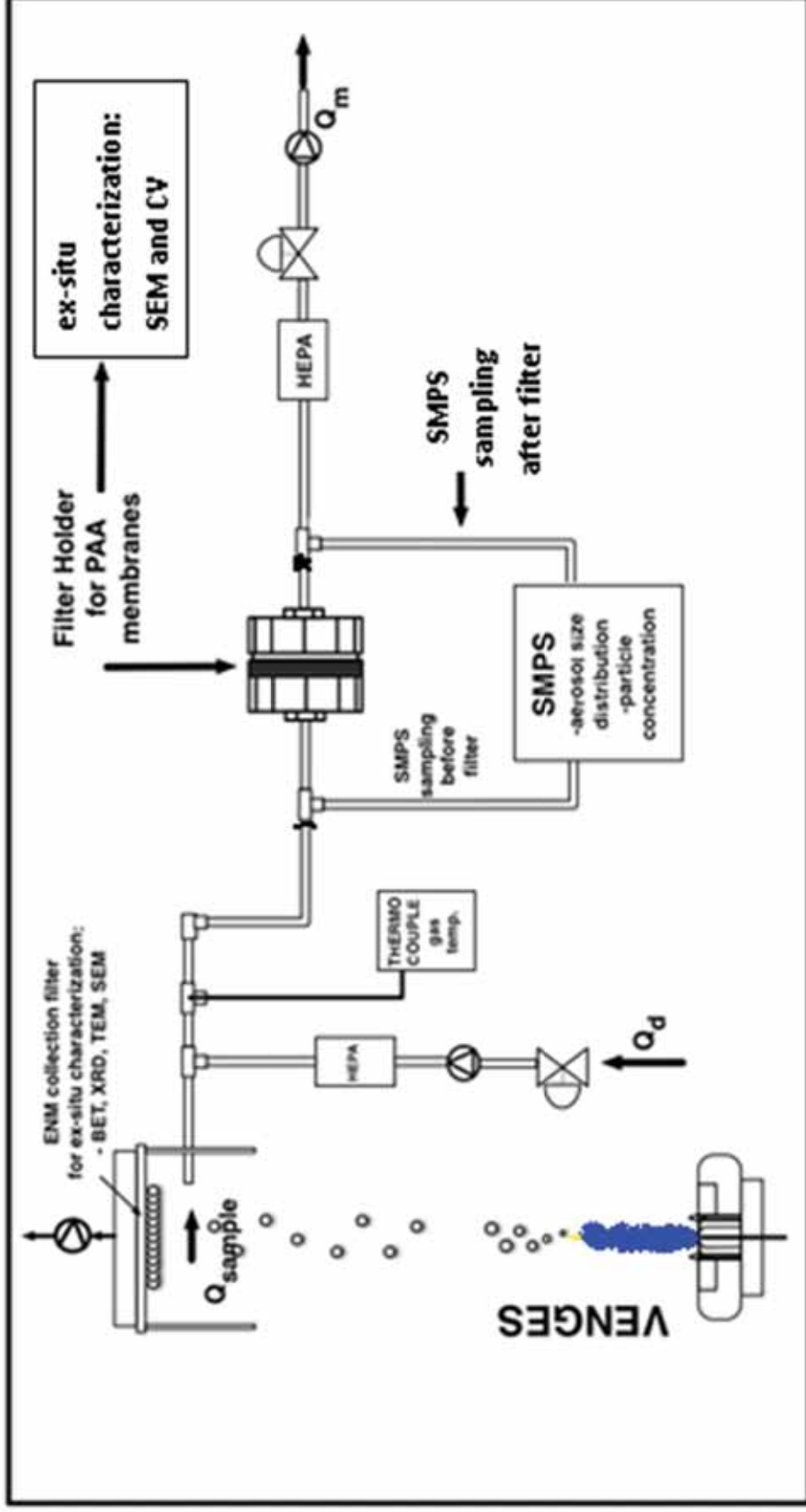

Surface Characterization

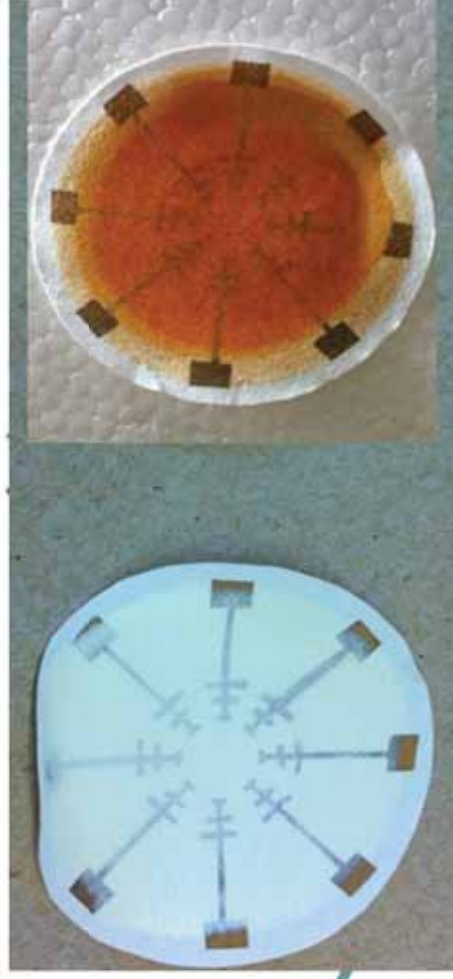
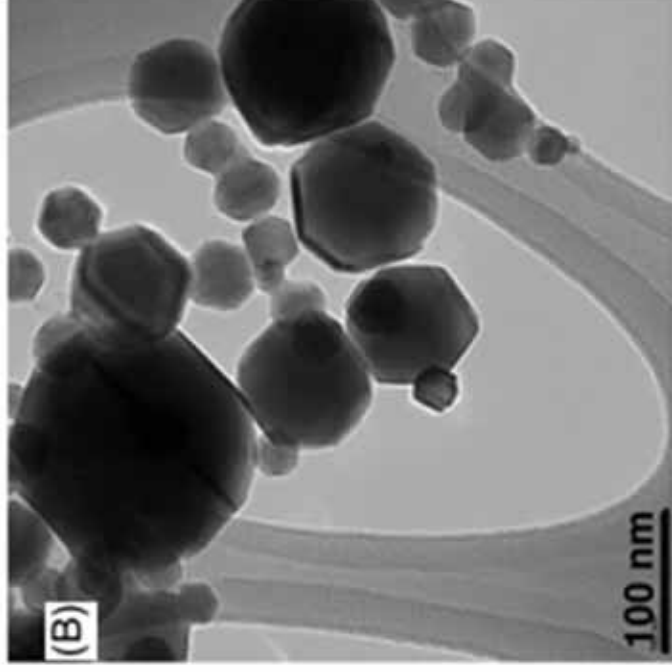
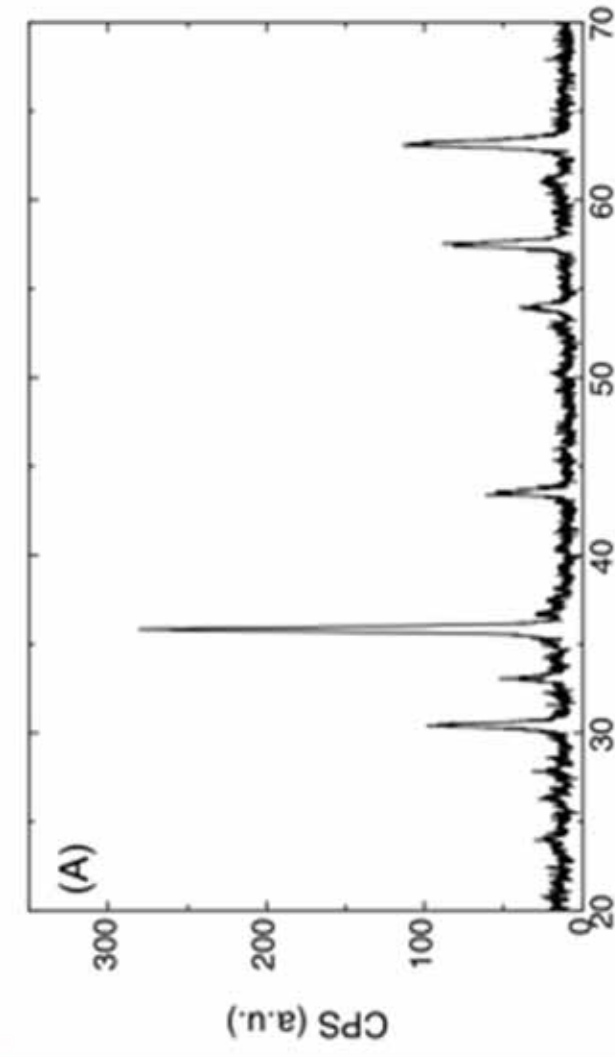

Proposal for Going Forward

- ❑ Develop the necessary calibration and validation tools
- ❑ Develop SRMs and the analytical quality control tools
- ❑ Develop acceptable standards testbeds & characterization centers

Overcoming Present Challenges

- **Develop acceptable SRMs**
 - Depends on testbeds
- **Calibration/validation tools**
- **Standardization and Testing Centers**
- **Develop training manuals & SOPs**
- **Define measures of success**

NANOSENSOR Commercialization

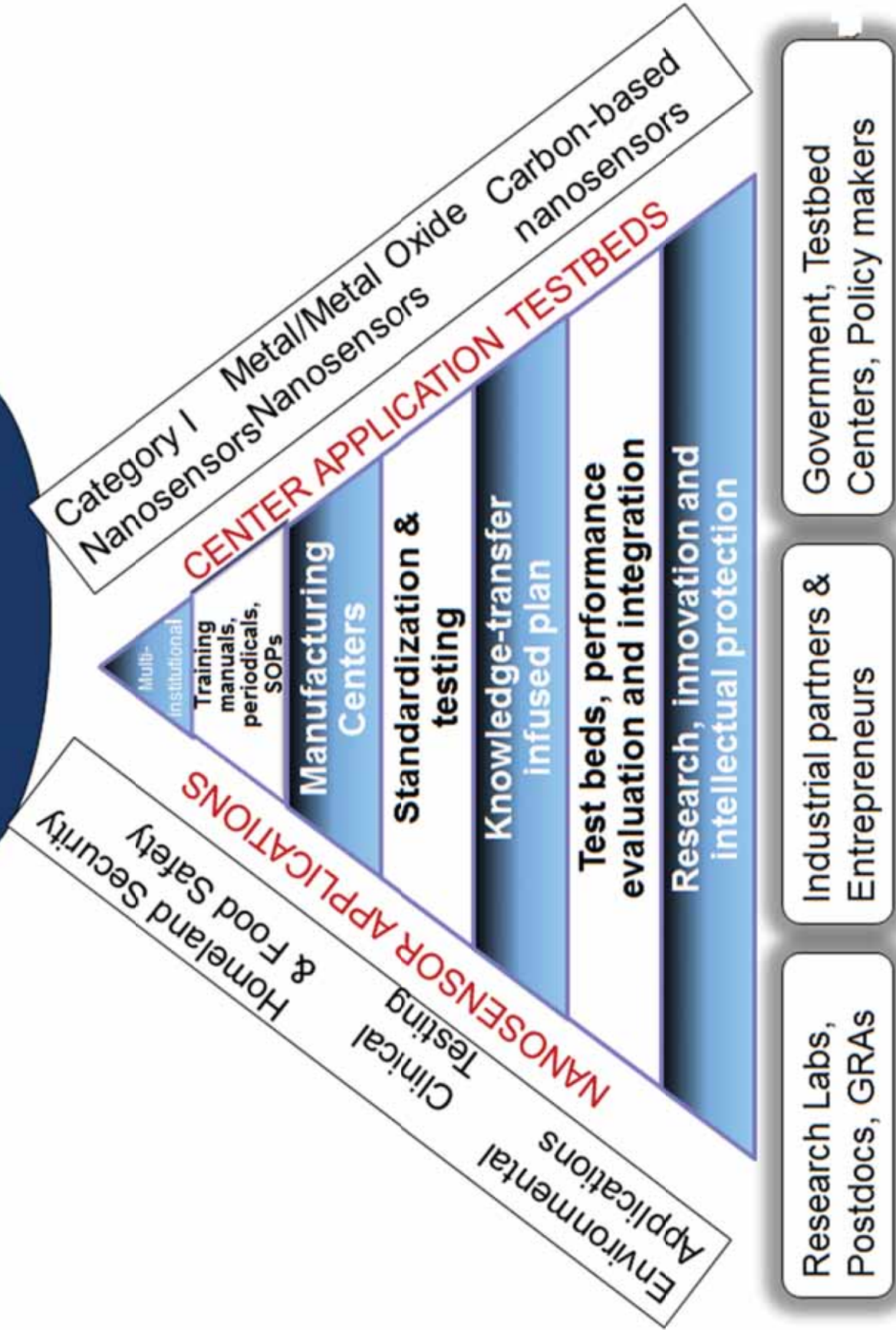

Test beds depend on the application

- **Health**
- **Food**
- **Pharmaceutical**
- **Process**
- **Environmental**
- **Defense & Security**

Testbed Specifications

- Environmental sensor should be sensitive, specific, provide fast response, must be reliable, flexible and capable of rapid and direct detection of toxic compounds.
- Additionally, there should be no need for sample preparation steps when analyzing environmental matrices or point-of-care biomedical samples.
- The sensor should be capable of convenient signal processing that will allow immediate remedial actions to be taken after detection

Environmental and Clinical Requirements

- **Precision, accuracy, measurement range, total error**
- **Interference**
- **Reference**
- **Response time**
- **Calibration**
- **Manufacturing**
- **Single use Vs. multi-use**

Nanosensor Performance Metrics-EPA QA/QC

- **Data quality parameters**
 - Precision, accuracy, LOD, robustness etc
- **Method Determination**
 - Method positive control, matrix spike, negative control(buffers, blanks, reagent water)
- **Frequency**
 - With every field sample, 1/batch or 20 samples, 10% of field samples, all standards, blanks, samples
- **Quality objective & Comparability**
 - % RSD, MDL, intended use of data
- **Designated Analytical Levels.**

● Sadik et. al, *Journal of Environmental Monitoring*, 6,513-522, **2004**; US-EPA (1995) and revisions. *Test Methods for Evaluating Solid Waste & Emergency Response*, Washington DC.

Performance Metrics

- Experimental variables should be defined
 - Sensitivity should be defined
 - Selectivity and reliability (false positives and false negatives) should be assessed using SOPs.
 - Optimization of experimental variables influencing sensor selectivity and sensitivity as well as the transfer to manufacturing platforms.
- Comparable to standard EPA, AOAC or FDA methods.

Conclusions -Needs of the Community)

- Manufacturing must produce stable sensors with uniform and non-distortable signals across sensing area
- Sensor layers must be mounted with a suitable transducer that does not distort them
- Unpreventable calibration errors in the devices must be reduced to an acceptable level
- Developing QC for the sensor industry requires the collaboration between the manufacturing, government, and research laboratories



U.S. EPA - Science To Achieve
Results (STAR) Program
Grant #



STARLink